



LED T-Grid Linear Light

Elegant LED module with T-Grid bracket that allows for ultimate flexibility. This versatile luminaire is compatible with any T-Grids. There are two sizes available in 2' and 4' with the width of 9/16" and 15/16" respectively. T-Grid LED can be installed in many configurations by replacing any of the cross tees between the main runners of the grid ceiling assembly in any open spaces that require a unique and elegant architectural lighting design.

Features and benefits

- Zolu Lighting quality and reliability
- Slim, convenient and elegant
- Dedicated for suspended grid ceiling system
- Convenient installation, one-step in place
- T-Bar grid type: (Armstrong) Predule XL 15/16" (USG Donn) DX, DXL, CE, DXLA, ZXLA, AX, DXSS

Applications

- Airport, educational, hospitality, hotels
- Architectural lighting design.

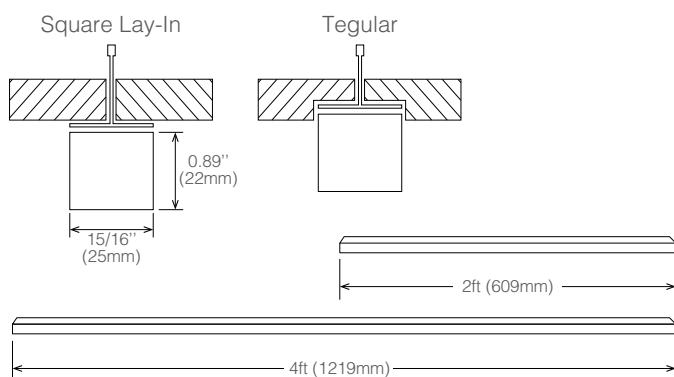

Driver capacity

Lamp size	35W	60W	100W
2Ft	2 units	4 units	7 units
4Ft	1 unit	2 units	4 units

• NOTE: Drivers sold separately.

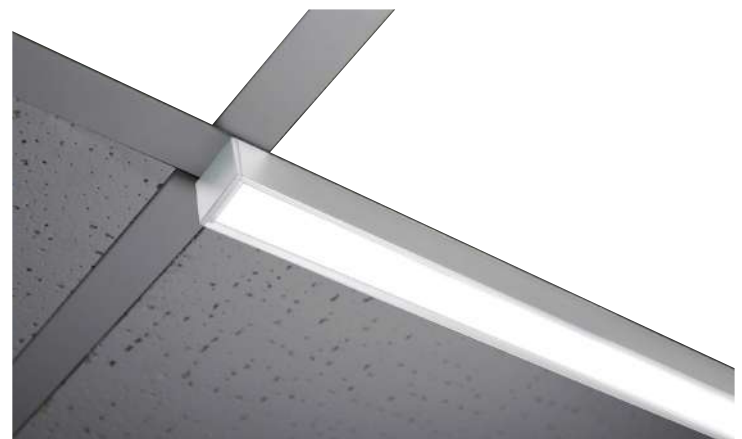



LED T-Grid Linear Light - Diffuser

Technical specifications

Product code	Power	Light output	Size	Optical system
ZL12W2FTGXK-D	12W	1100lm	2ft	Diffuser
ZL24W2FTGXK-D	24W	2200lm	4ft	Diffuser

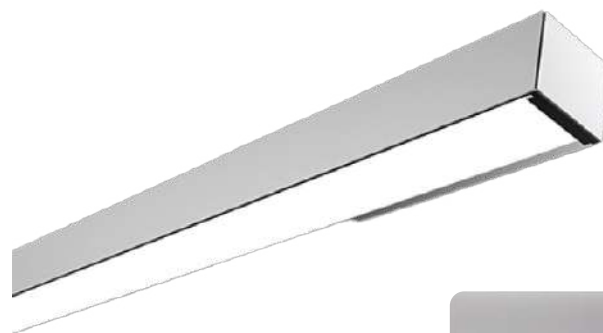
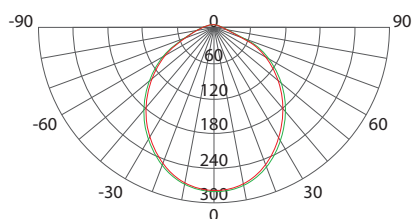

Main voltage	24V DC
Efficiency	92lm/W
CCT	3000K / 3500K / 4000K / 5000K
CRI	Ra>80 (90 optional)
Grid type	15/16"
Lens angle	100°
Dimmable	0-10V Dim
Driver compatibility	35LV-24V / 60LV-24V / 100LV-24V
Life span	50,000hrs
Warranty	5 Year

• NOTE: Indoor use only.



LED T-Grid Linear Light - Microprism

Technical specifications

Product code	Power	Light output	Size	Optical system
ZL12W2FTGXK-M	12W	1200lm	2ft	Microprism
ZL24W2FTGXK-M	24W	2400lm	4ft	Microprism

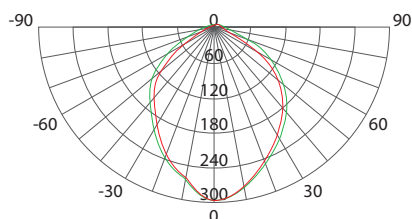

Main voltage	24V DC
Efficiency	100lm/W
CCT	3000K / 3500K / 4000K / 5000K
CRI	Ra>80 (90 optional)
Grid type	15/16"
Lens angle	90°
Dimmable	0-10V Dim
Driver compatibility	35LV-24V / 60LV-24V / 100LV-24V
Life span	50,000hrs
Warranty	5 Year

• NOTE: Indoor use only.



LED T-Grid Linear Light - Grating

Technical specifications

Product code	Power	Light output	Size	Optical system
ZL12W2FTGXK-G	12W	900lm(30°) / 700lm(60°)	2ft	Grating
ZL24W2FTGXK-G	24W	1800lm(30°) / 1400lm(60°)	4ft	Grating

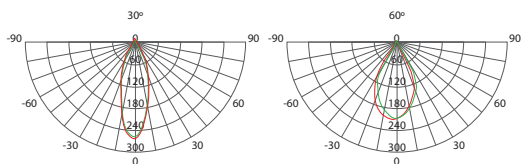

Main voltage	24V DC
Efficiency	75lm/W - 58lm/W
CCT	3000K / 3500K / 4000K / 5000K
CRI	Ra>80 (90 optional)
Grid type	15/16"
Lens angle	30° - 60°
Dimmable	0-10V Dim
Driver compatibility	35LV-24V / 60LV-24V / 100LV-24V
Life span	50,000hrs
Warranty	5 Year

• NOTE: Indoor use only.



LED T-Grid Linear Light - Asymmetric

Technical specifications

Product code	Power	Light output	Size	Optical system
ZL12W2FTGXK-A	12W	1500lm	2ft	Asymmetric
ZL24W2FTGXK-A	24W	3000lm	4ft	Asymmetric

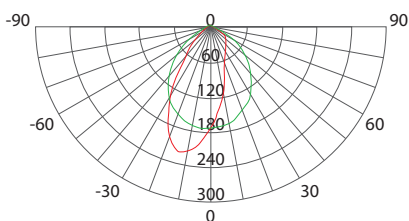

Main voltage	24V DC
Efficiency	125lm/W
CCT	3000K / 3500K / 4000K / 5000K
CRI	Ra>80 (90 optional)
Grid type	15/16"
Lens angle	90°x45°x15°
Dimmable	0-10V Dim
Driver compatibility	35LV-24V / 60LV-24V / 100LV-24V
Life span	50,000hrs
Warranty	5 Year

• NOTE: Indoor use only.



LED T-Grid Linear Light - Double Asymmetric

Technical specifications

Product code	Power	Light output	Size	Optical system
ZL12W2FTGXXK-DA	12W	1500lm	2ft	Double asymmetric
ZL24W2FTGXXK-DA	24W	3000lm	4ft	Double asymmetric

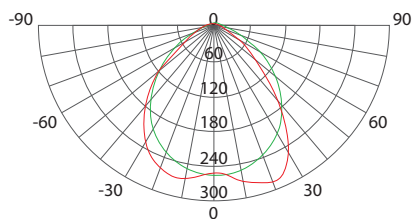

Main voltage	24V DC
Efficiency	125lm/W
CCT	3000K / 3500K / 4000K / 5000K
CRI	Ra>80 (90 optional)
Grid type	15/16"
Lens angle	100°x90°
Dimmable	0-10V Dim
Driver compatibility	35LV-24V / 60LV-24V / 100LV-24V
Life span	50,000hrs
Warranty	5 Year

• NOTE: Indoor use only.

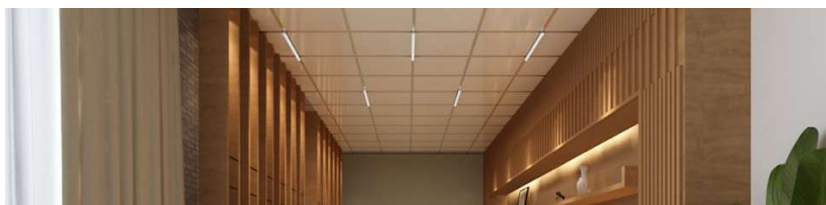

LED T-Grid Linear Light - Block Frosted

Technical specifications

Product code	Power	Light output	Size	Optical system
ZL12W2FTGXXK-B	12W	1400lm	2ft	Block frosted
ZL24W2FTGXXK-B	24W	2800lm	4ft	Block frosted

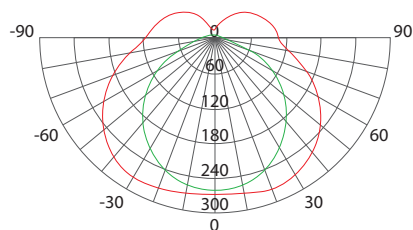

Main voltage	24V DC
Efficiency	117lm/W
CCT	3000K / 3500K / 4000K / 5000K
CRI	Ra>80 (90 optional)
Grid type	15/16"
Lens angle	165°
Dimmable	0-10V Dim
Driver compatibility	35LV-24V / 60LV-24V / 100LV-24V
Life span	50,000hrs
Warranty	5 Year

• NOTE: Indoor use only.